



(V) Preliminary Specification

() Final Specification

Module	22" WXGA+ Color TFT-LCD
Model Name	T220SW01 V0

Customer	Date
_____	_____
Approved by	
_____	_____
Note: This Specification is subject to change without notice.	

Checked & Approved by	Date
Prepared by	
Desktop Display Business Group / AU Optronics corporation	



Contents

1. Handling Precautions	3
2. General Description	5
2.1 Display Characteristics	5
3. Functional Block Diagram	10
4. Absolute Maximum Ratings	11
4.1 Absolute Ratings of TFT LCD Module.....	11
4.2 Absolute Ratings of Backlight Unit.....	11
4.3 Absolute Ratings of Environment	12
5. Electrical characteristics	13
5.1 TFT LCD Module	13
5.2 Backlight Unit	14
6. Signal Characteristic	15
6.1 Pixel Format Image	15
6.2 The Input Data Format.....	17
6.4 Interface Timing	20
6.5 Power ON/OFF Sequence	22
7. Connector & Pin Assignment	22
7.1 TFT LCD Module	23
7.2 Backlight Unit	24
8. Reliability Test	25
9. Shipping Label	26
10. Mechanical Characteristics	26



Product Specification

T220SW01 V0

AU OPTRONICS CORPORATION

1. Handling Precautions

- 1) Since front polarizer is easily damaged, pay attention not to scratch it.
- 2) Be sure to turn off power supply when inserting or disconnecting from input connector.
- 3) Wipe off water drop immediately. Long contact with water may cause discoloration or spots.
- 4) When the panel surface is soiled, wipe it with absorbent cotton or other soft cloth.
- 5) Since the panel is made of glass, it may break or crack if dropped or bumped on hard surface.
- 6) Since CMOS LSI is used in this module, take care of static electricity and insure human earth when handling.
- 7) Do not open or modify the Module Assembly.
- 8) Do not press the reflector sheet at the back of the module to any directions.
- 9) In case if a Module has to be put back into the packing container slot after once it was taken out from the container, do not press the center of the CCFL reflector edge. Instead, press at the far ends of the CCFL Reflector edge softly. Otherwise the TFT Module may be damaged.
- 10) At the insertion or removal of the Signal Interface Connector, be sure not to rotate nor tilt the Interface Connector of the TFT Module.
- 11) After installation of the TFT Module into an enclosure, do not twist nor bend the TFT Module even momentary. At designing the enclosure, it should be taken into consideration that no bending/twisting forces are applied to the TFT Module from outside. Otherwise the TFT Module may be damaged.
- 12) Cold cathode fluorescent lamp in LCD contains a small amount of mercury. Please follow local ordinances or regulations for disposal.
- 13) Small amount of materials having no flammability grade is used in the LCD module. The LCD module should be supplied by power complied with requirements of Limited Power Source (IEC60950 or UL1950), or be applied exemption.
- 14) The LCD module is designed so that the CCFL in it is supplied by Limited Current Circuit (IEC60950 or UL1950). Do not connect the CCFL in Hazardous Voltage Circuit.



2. General Description

This specification applies to the 22 inch-wide Color TFT-LCD Module T220EW01.

The display supports the WSXGA+ (1680(H) x 1050(V)) screen format and 16.7M colors. All input signals are 2 Channel LVDS interface compatible.

This module does not contain an inverter card for backlight.

2.1 Display Characteristics

The following items are characteristics summary on the table under 25 °C condition:

Items	Unit	Specifications
Active Area	[mm]	473.76 (H) x 296.1(V)
Pixels H x V		1680x3(RGB) x 1050
Pixel Pitch	[mm]	0.282x 0.282
Pixel Arrangement		R.G.B. Vertical Stripe
Display Mode		TN Mode, Normally White
White Luminance	[cd/m ²]	300 cd/m ² @ 7.0mA (Typ)
Contrast Ratio		1000:1 (Typ)
Optical ResponseTime	[msec]	5 (Typ, on/off)
Nominal Input Voltage VDD	[Volt]	+5.0 V
Power Consumption (VDD line + CCFL line)	[Watt]	28.5W (Typ) (Without Invertor, All black pattern)
Weight	[Grams]	2385 Note1
Physical Size (H x V x D)	[mm]	493.7(W) x 320.1(H) x 16.5(D) (Typ)
Electrical Interface		Dual Channel LVDS
Support Colors		16.7M colors (6-bits + HiFRC)
Temperature Range Operating Storage (Shipping)	[°C] [°C]	0 to +50 -20 to +60
Surface Treatment		Hard-coating (3H), Non-glare type
RoHS Compliance		RoHS Compliance

Note1: 2500 gm (Max)

2.2 Optical Characteristics

The optical characteristics are measured under stable conditions at 25°C (Room Temperature):

Item	Unit	Conditions	Min.	Typ.	Max.	Note
Viewing Angle	[degree]	Horizontal (Right)+ (Left) CR = 10	160	170	-	1
		Vertical (Up) + (Down) CR = 10	150	160	-	
Luminance Uniformity	[%]	9 Points	75	80	-	2, 3
Optical Response Time	[msec]	Rising	-	3.6	5.7	4, 6
		Falling	-	1.4	2.3	
		Rising + Falling	-	5	8	
Color / Chromaticity Coordinates (CIE 1931)		Red x	0.616	0.646	0.676	4
		Red y	0.309	0.339	0.369	
		Green x	0.260	0.290	0.320	
		Green y	0.573	0.603	0.633	
		Blue x	0.115	0.145	0.175	
		Blue y	0.040	0.070	0.100	
		White x	0.283	0.313	0.343	
		White y	0.299	0.329	0.359	
White Luminance (At CCFL= 7.0mA)	[cd/m ²]		250	300	-	4
Contrast Ratio		Normal Direction	800	1000	-	4
Cross Talk (At 75Hz)	[%]		-	-	1.5	5
Flicker	[dB]		-	-	-20	7

Optical Equipment: BM-5A, BM-7, PR880, or equivalent

Note 1: Definition of viewing angle: measured by **ELDIM (EZContrast 88)**

Viewing angle is the measurement of contrast ratio ≥ 10 , at the screen center, over a 180° horizontal and 180° vertical range (off-normal viewing angles). The 180° viewing angle range is broken down as follows; 90° (θ) horizontal left and right and 90° (Φ) vertical, high (up) and low (down). The measurement direction is typically perpendicular to the display surface with the screen rotated about its center to develop the desired measurement viewing angle.

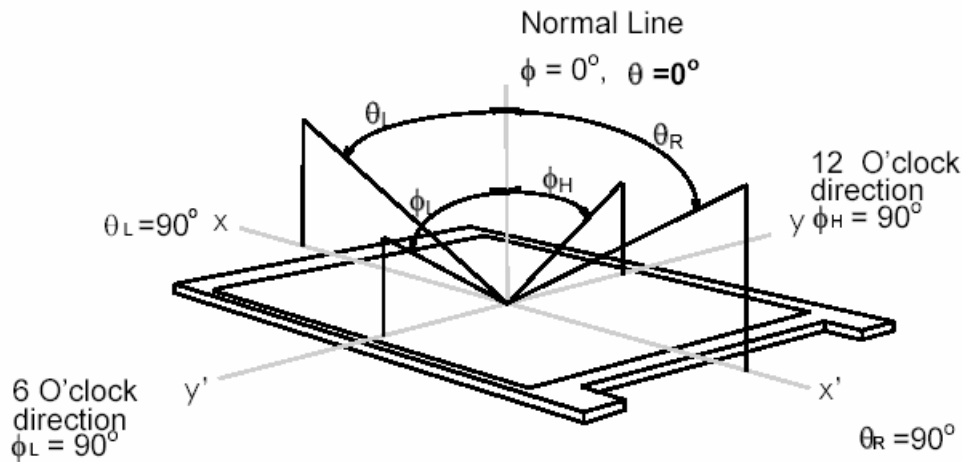

Note 2: 9 points position

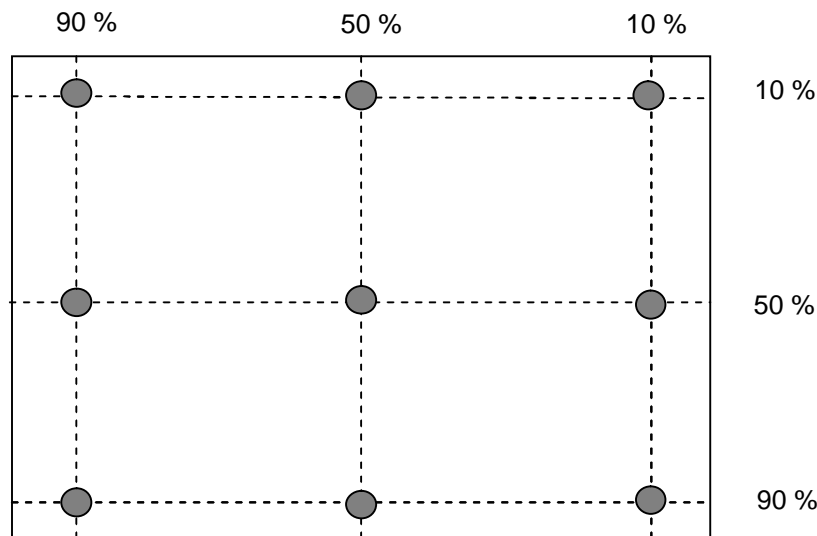

Note 3: The luminance uniformity of 9 points is defined by dividing the maximum luminance values by the minimum test point luminance

$$\delta_{w9} = \frac{\text{Minimum Luminance of 9 points}}{\text{Maximum Luminance of 9 points}}$$

Note 4: Measurement method

The LCD module should be stabilized at given temperature for 30 minutes to avoid abrupt temperature change during measuring. In order to stabilize the luminance, the measurement should be executed after lighting Backlight for 30 minutes in a stable, windless and dark room.

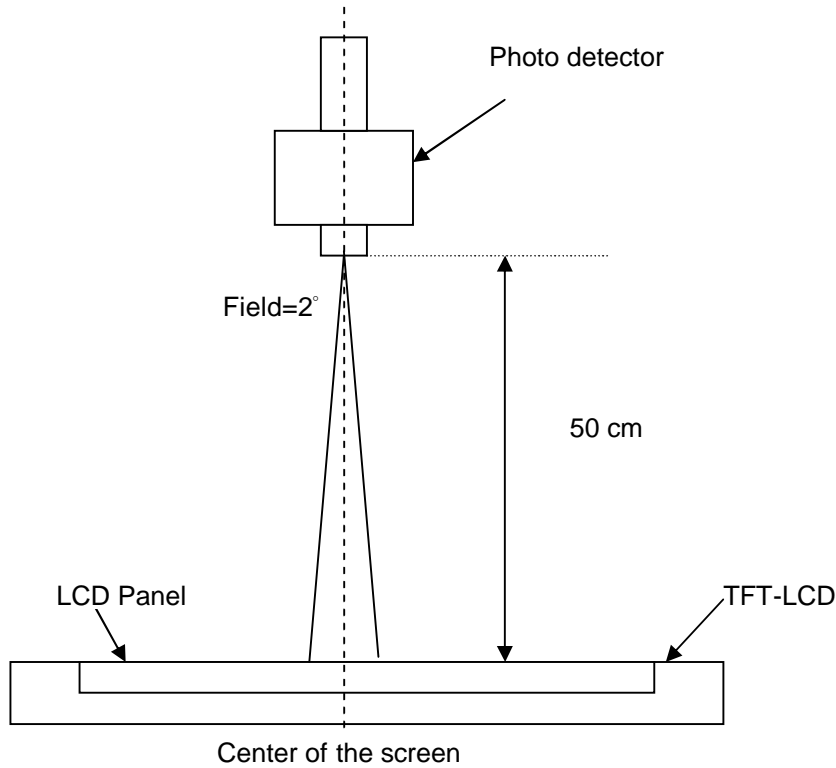

Note 5: Definition of Cross Talk (CT)

$$CT = |Y_B - Y_A| / Y_A \times 100 (\%)$$

Where

Y_A = Luminance of measured location without gray level 0 pattern (cd/m²)

Y_B = Luminance of measured location with gray level 0 pattern (cd/m²)

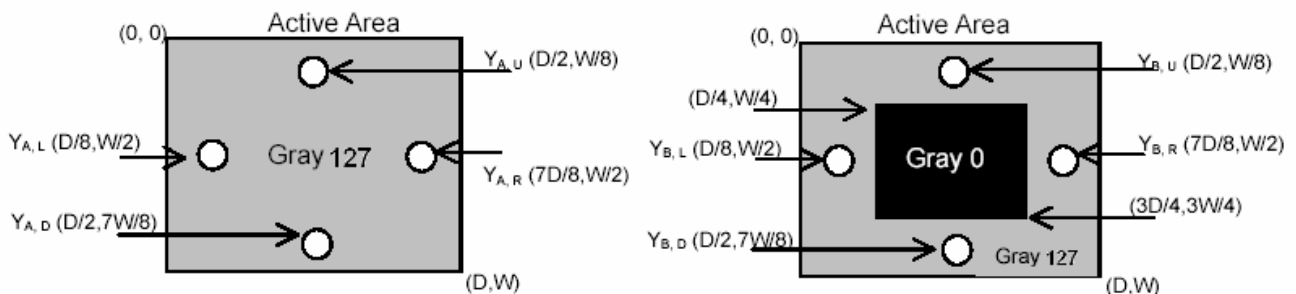

Note 6: Definition of response time:

The output signals of photo detector are measured when the input signals are changed from “Full Black” to “Full White” (rising time), and from “Full White” to “Full Black” (falling time), respectively. The response time is interval between the 10% and 90% of amplitudes. Please refer to the figure as below.

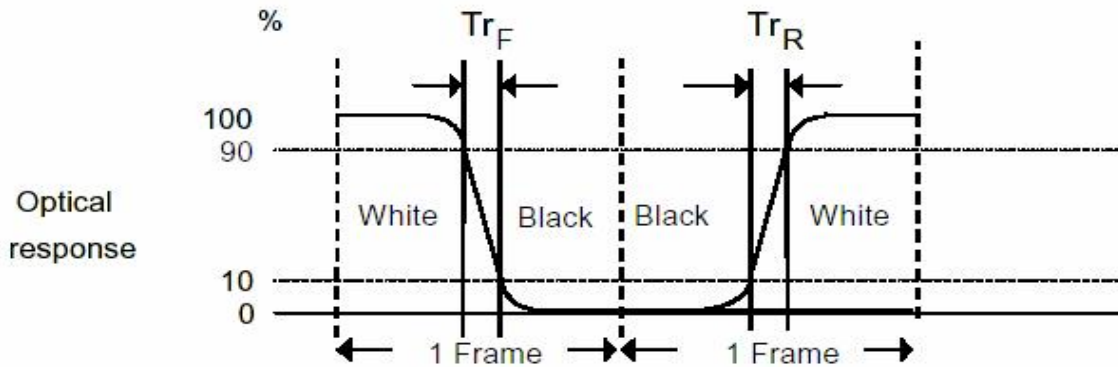

Note 7: Subchecker Pattern

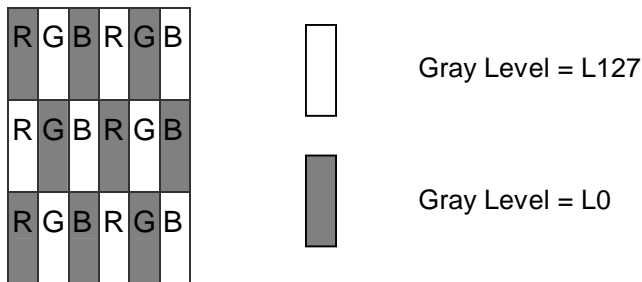

Method: Record dBV & DC value with (WESTAR)TRD-100

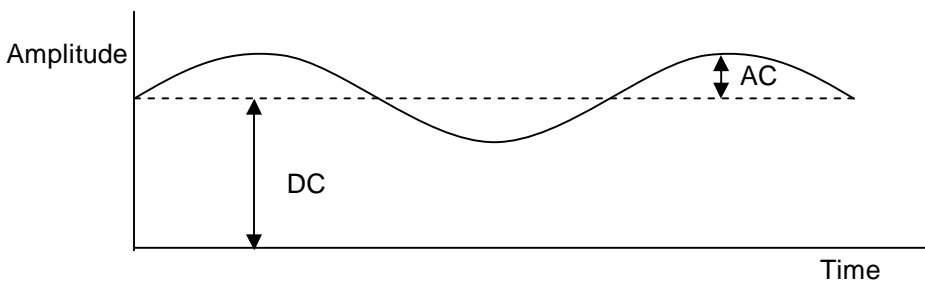

$$\text{Flicker (dB)} = 20 \log \frac{\text{AC Level(at 30 Hz)}}{\text{DC Level}}$$

3. Functional Block Diagram

The following diagram shows the functional block of the 22 inches wide Color TFT-LCD Module:

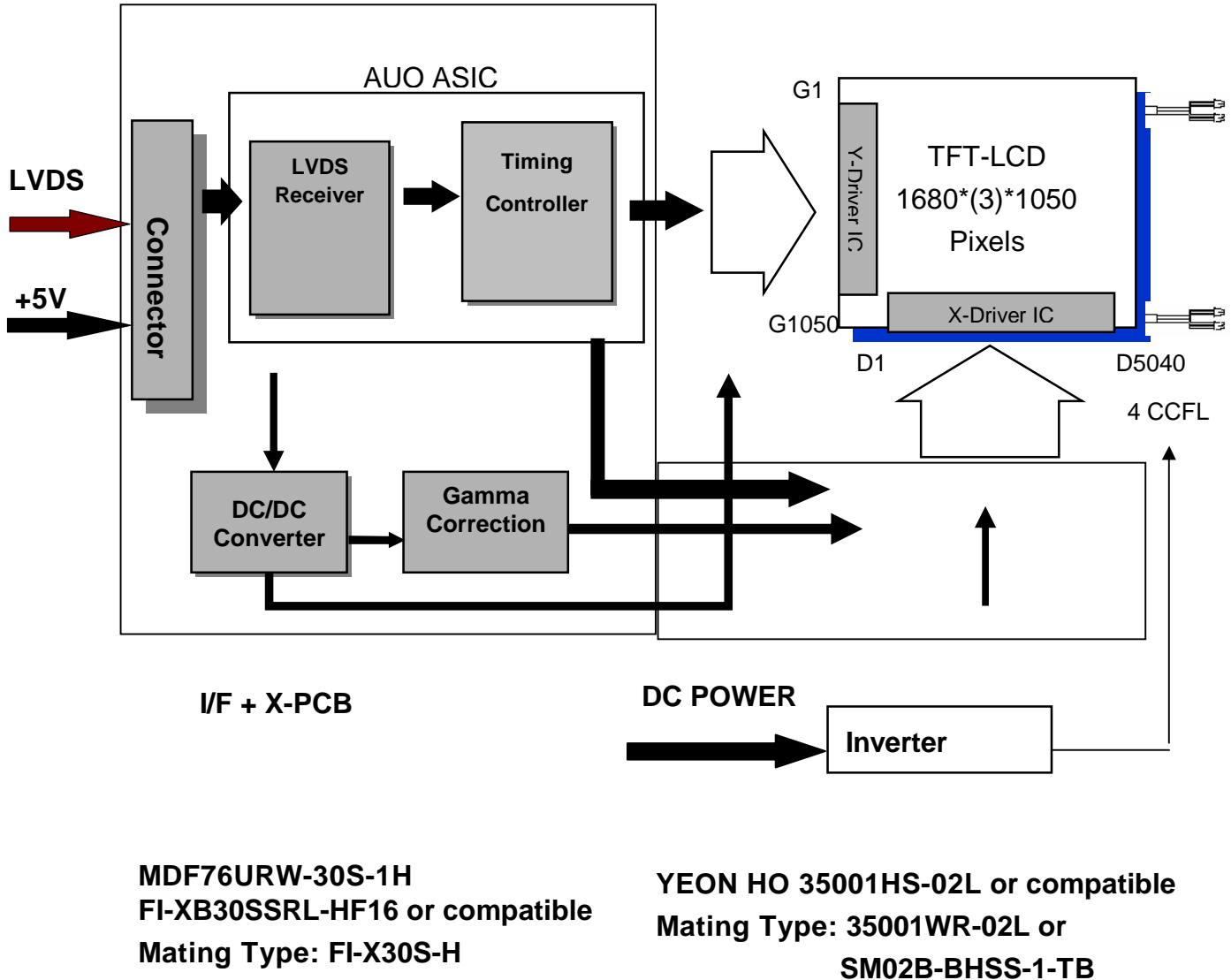



4. Absolute Maximum Ratings

Absolutely maximum rating of the module is as following:

4.1 Absolute Ratings of TFT LCD Module

Item	Symbol	Min.	Max.	Unit	Conditions
Logic/LCD Drive Voltage	VDD	-0.3	+5.5	[Volt]	Note 1, 2

4.2 Absolute Ratings of Backlight Unit

Item	Symbol	Min.	Max.	Unit	Conditions
CCFL Current	ICFL	-	8	[mA] rms	Note 1, 2

4.3 Absolute Ratings of Environment



Item	Symbol	Min.	Max.	Unit	Conditions
Operating Temperature	TOP	0	+50	[°C]	Note 3
Operation Humidity	HOP	5	90	[%RH]	
Storage Temperature	TST	-20	+60	[°C]	
Storage Humidity	HST	8	90	[%RH]	

Note 1: With in $T_a = 25^\circ\text{C}$

Note 2: Permanent damage to the device may occur if exceed maximum values

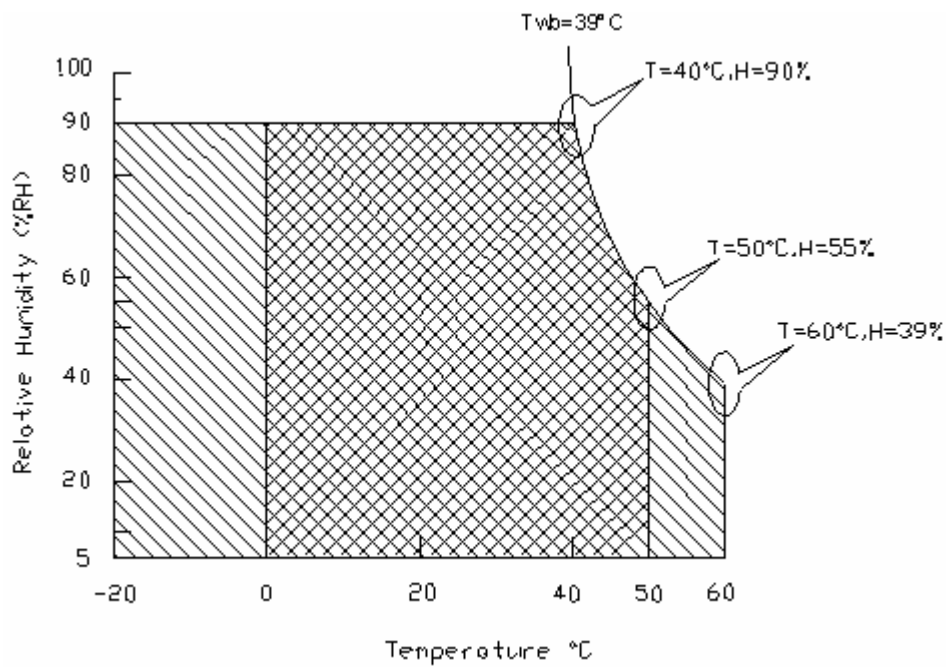
Note 3: For quality performance, please refer to AUO IIS (Incoming Inspection Standard).



Operating Range  Storage Range  + 

5. Electrical characteristics

5.1 TFT LCD Module

5.1.1 Power Specification

Input power specifications are as follows:

Symble	Parameter	Min.	Typ.	Max.	Unit	Condition
VDD	Logic/LCD Drive Voltage	4.5	5.0	5.5	[Volt]	± 10%
IDD	Input Current	-	1000	1400	[mA]	VDD= 5.0V, All Black Pattern At 60Hz
PDD	VDD Power	-	5	7	[Watt]	VDD= 5.0V, All Black Pattern At 60Hz , Note 1
IRush	Inrush Current	-	-	2.5	[A]	Note 2
VDDrp	Allowable logic/LCD Drive Ripple Voltage			200	[mV] p-p	VDD=5.0, All black pattern at 75Hz

Note 1: The variance of VDD power consumption is ±10%.

Note 2: Measurement conditions:

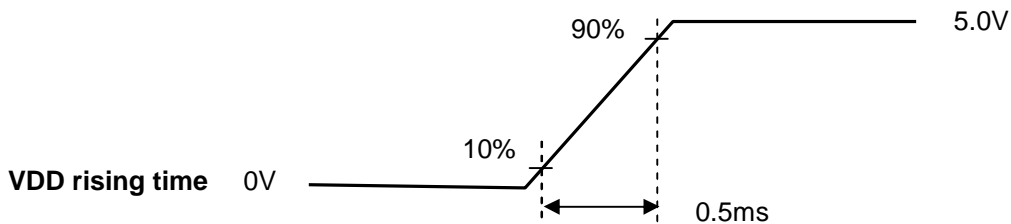
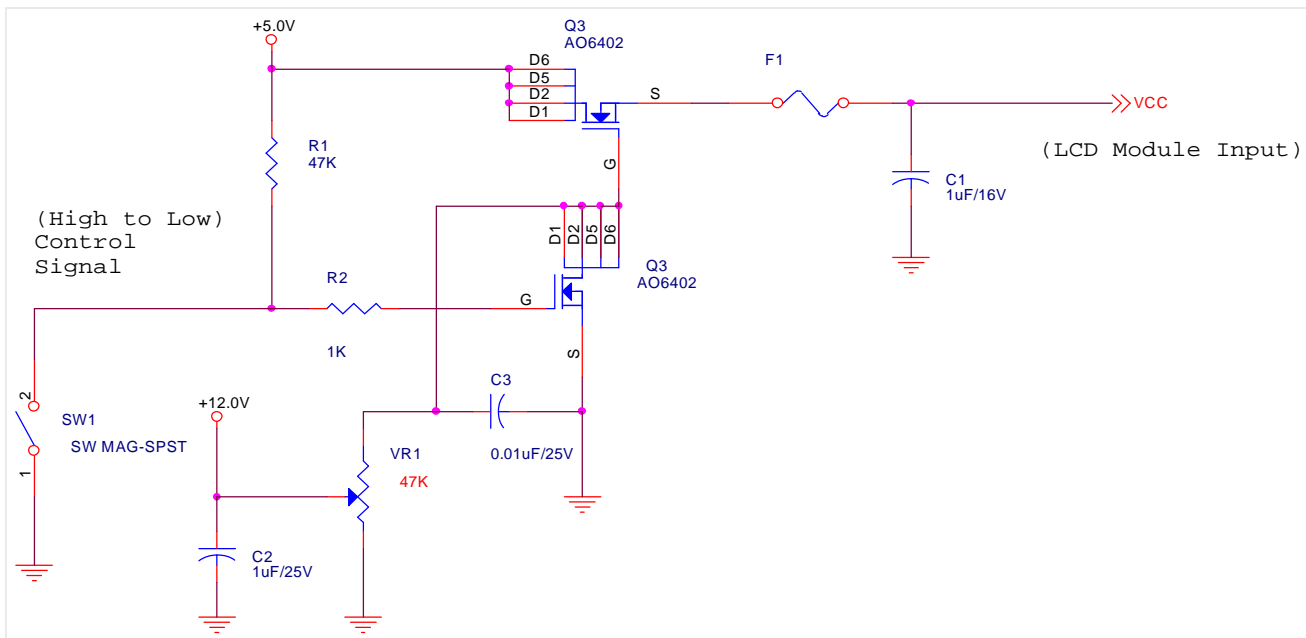

5.1.2 Signal Electrical Characteristics

Input signals shall be low or Hi-Z state when Vin is off

It is recommended to refer the specifications of SN75LVDS82DGG (Texas Instruments) in detail.

Each signal characteristics are as follows;

Symbol	Parameter	Min	Typ	Max	Units	Condition
VTH	Differential Input High Threshold	-	-	100	[mV]	VICM = 1.2V Note
VTL	Differential Input Low Threshold	-100	-	-	[mV]	VICM = 1.2V Note
VID	Input Differential Voltage	100	400	600	[mV]	Note
VICM	Differential Input Common Mode Voltage	0.3	-	1.25	[V]	VDD=3.3V ± 0.05%

Note: LVDS Signal Waveform

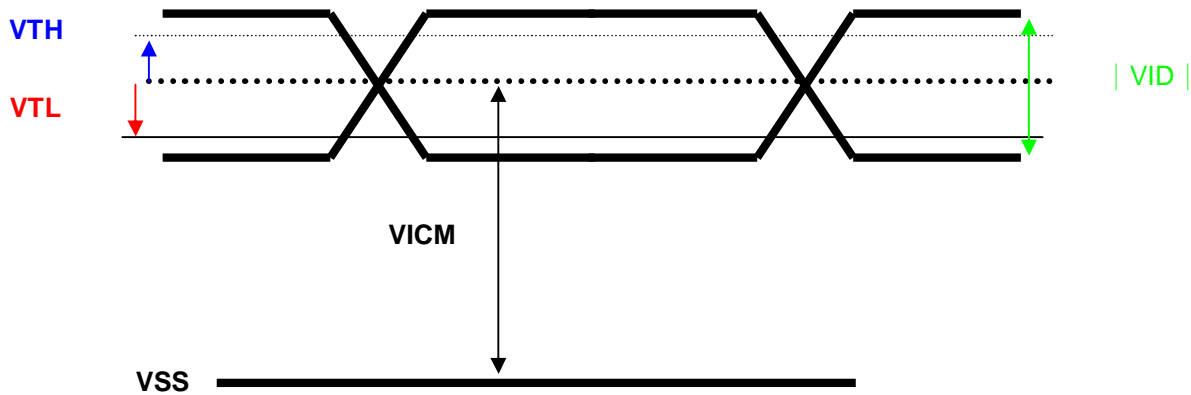

5.2 Backlight Unit

Parameter guideline for CCFL Inverter is under stable conditions at 25°C (Room Temperature):

Parameter	Min.	Typ.	Max.	Unit	Condition
CCFL Standard Current (ISCFL)	6.5	7.0	7.5	[mA] rms	Note 2
CCFL Operation Current(IRCFL)	3.5	7.0	8.0	[mA] rms	Note 2
CCFL Frequency(FCFL)	40	50	60	[KHz]	Note 3,4
CCFL Ignition Voltage(ViCFL, Ta= 0°C) (End of the lamp wire connector)	1730	-	-	[Volt] rms	Note 5
CCFL Ignition Voltage(ViCF, Ta= 25°C) (End of the lamp wire connector)	1330	-	-	[Volt] rms	
CCFL Operation Voltage (VCFL)	-	800 (@ 7.0mA)		[Volt] rms	Note 6
CCFL Power Consumption(PCFL)	-	22.4	24.5	[Watt]	Note 6
CCFL Life Time(LTCFL)	40,000	50,000	-	[Hour]	Note 7

Note 1: Typ. are AUO recommended design points.

- *1 All of characteristics listed are measured under the condition using the AUO test inverter.
- *2 In case of using an inverter other than listed, it is recommended to check the inverter carefully. Sometimes, interfering noise stripes appear on the screen, and substandard luminance or flicker at low power may happen.
- *3 In designing an inverter, it is suggested to check safety circuit very carefully. Impedance of CCFL, for instance, becomes more than 1 [M ohm] when CCFL is damaged.
- *4 Generally, CCFL has some amount of delay time after applying kick-off voltage. It is recommended to keep on applying kick-off voltage for 1 [Sec] until discharge.
- *5 Reducing CCFL current increases CCFL discharge voltage and generally increases CCFL discharge frequency. So all the parameters of an inverter should be carefully designed so as not to produce too much leakage current from high-voltage output of the inverter.

Note 2: It should be employed the inverter which has "Duty Dimming", if IRCFL is less than 4mA.

Note 3: CCFL discharge frequency should be carefully determined to avoid interference between inverter and TFT LCD.

Note 4: The frequency range will not affect to lamp life and reliability characteristics.

Note 5: CCFL inverter should be able to give out a power that has a generating capacity of over 1,500 voltage. Lamp units need 1,500 voltage minimum for ignition.

Note 6: The variance of CCFL power consumption is ±10%. Calculator value for reference (ISCFL × VCFL × 4 = PCFL)

Note 7: Definition of CCFL life Time (LTCFL): brightness becomes 50%. (The typical life time of CCFL is on the condition at 7.0 mA lamp current).

6. Signal Characteristic

6.1 Pixel Format Image

Following figure shows the relationship of the input signals and LCD pixel format.

6.2 The Input Data Format

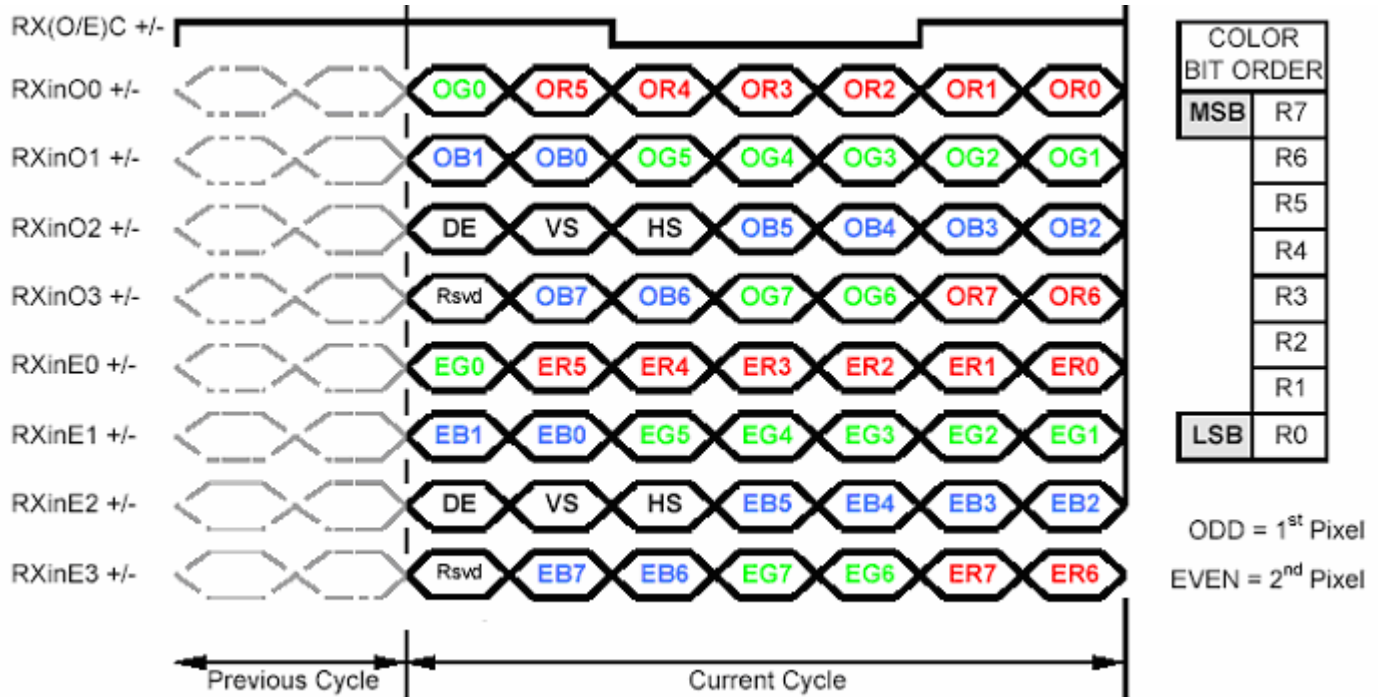

Note1: Normally, DE, VS, HS on EVEN channel are not used.

Note2: 8-bits signal input.

Note3: L:NS alike H:Thine alike

6.3 Signal Description

The module using a pair of LVDS receiver SN75LVDS82(Texas Instruments) or compatible. LVDS is a differential signal technology for LCD interface and high speed data transfer device. Transmitter shall be SN75LVDS83(negative edge sampling) or compatible. The first LVDS port(RxOxxx) transmits odd pixels while the second LVDS port(RxExxx) transmits even pixels.

PIN #	SIGNAL NAME	DESCRIPTION
1	RxOIN0-	Negative LVDS differential data input (Odd data)
2	RxOIN0+	Positive LVDS differential data input (Odd data)
3	RxOIN1-	Negative LVDS differential data input (Odd data)
4	RxOIN1+	Positive LVDS differential data input (Odd data)
5	RxOIN2-	Negative LVDS differential data input (Odd data, H-Sync, V-Sync, DSPTMG)
6	RxOIN2+	Positive LVDS differential data input (Odd data, H-Sync, V-Sync, DSPTMG)
7	GND	Power Ground
8	RxOCLKIN-	Negative LVDS differential clock input (Odd clock)
9	RxOCLKIN+	Positive LVDS differential clock input (Odd clock)
10	RxOIN3-	Negative LVDS differential data input (Odd data)
11	RxOIN3+	Positive LVDS differential data input (Odd data)
12	RxEIN0-	Negative LVDS differential data input (Even data)
13	RxEIN0+	Positive LVDS differential data input (Even data)
14	GND	Power Ground
15	RxEIN1-	Positive LVDS differential data input (Even data)
16	RxEIN1+	Negative LVDS differential data input (Even data)
17	GND	Power Ground
18	RxEIN2-	Negative LVDS differential data input (Even data)
19	RxEIN2+	Positive LVDS differential data input (Even data)
20	RxECLKIN-	Negative LVDS differential clock input (Even clock)
21	RxECLKIN+	Positive LVDS differential clock input (Even clock)
22	RxEIN3-	Negative LVDS differential data input (Even data)
23	RxEIN3+	Positive LVDS differential data input (Even data)
24	GND	Power Ground
25	NC	No contact (For AUO test only)
26	NC	No contact (For AUO test only)
27	NC	No contact (For AUO test only)
28	VCC	+5.0V Power Supply
29	VCC	+5.0V Power Supply
30	VCC	+5.0V Power Supply

Note1: Start from left side

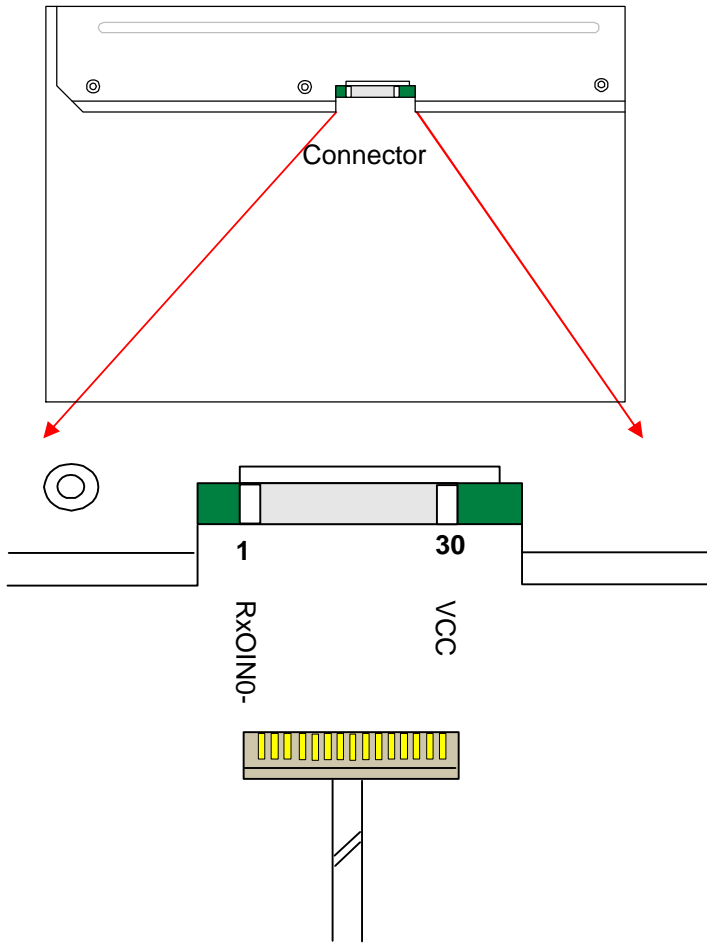

Note2: Input signals of odd and even clock shall be the same timing.

Note3: Please follow PSWG.

6.4 Interface Timing

6.4.1 Timing Characteristics

Signal	Item	Symbol	Min	Typ	Max	Unit
Vertical Section	Period	Tv	1058	1066	2048	Th
	Active	Tdisp(v)	1050	1050	1050	Th
	Blanking	Tbp(v)+Tfp(v)+PWvs	8	16	998	Th
Horizontal Section	Period	Th	880	1128	2048	Tclk
	Active	Tdisp(h)	840	840	840	Tclk
	Blanking	Tbp(h)+Tfp(h)+PWhs	40	288	1208	Tclk
Clock	Period	Tclk	11.76	13.86	16.67	ns
	Frequency	Freq.	60	72.1	85	MHz
Frame Rate	Frequency	1/Tv	50	60	75	Hz

Note : DE mode only

6.4.2 Timing Diagram

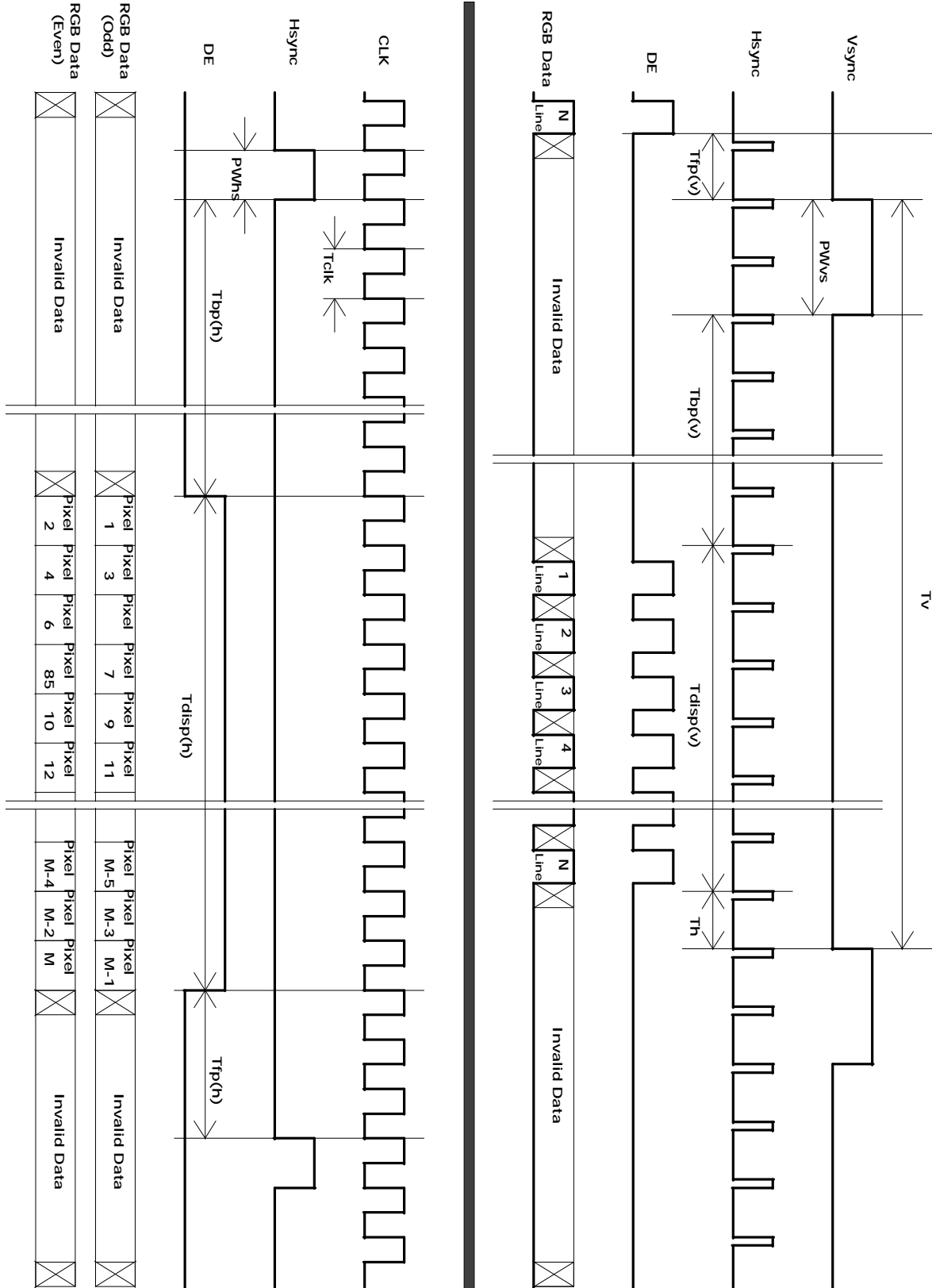

6.5 Power ON/OFF Sequence

VDD power and lamp on/off sequence is as follows. Interface signals are also shown in the chart. Signals from any system shall be Hi-Z state or low level when VDD is off.

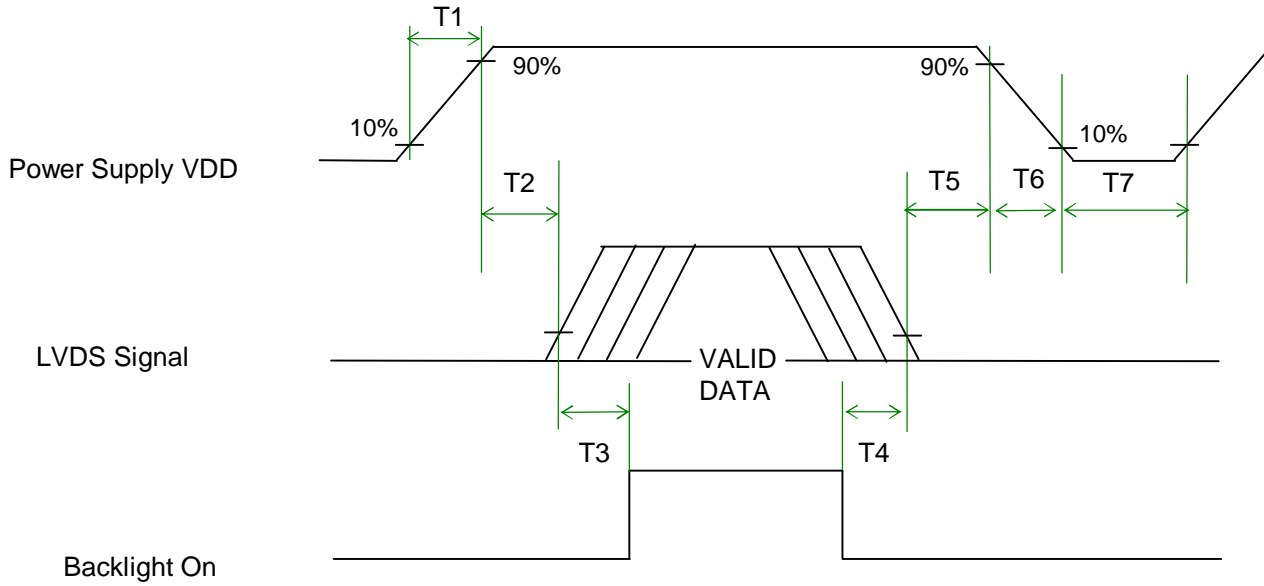

Power Sequence Timing

Parameter	Value			Unit
	Min.	Typ.	Max.	
T1	0.5	-	10	[ms]
T2	0	40	50	[ms]
T3	200	-	-	[ms]
T4	200	-	-	[ms]
T5	0.5	16	50	[ms]
T6	-	-	100	[ms]
T7	1000	-	-	[ms]

7. Connector & Pin Assignment

Physical interface is described as for the connector on module. These connectors are capable of accommodating the following signals and will be following components.

7.1 TFT LCD Module

7.1.1 Connector

Connector Name / Designation	Interface Connector / Interface card
Manufacturer	LVDS: HIROSE/ JAE or compatible
Type Part Number	LVDS :MDF76URW-30S-1H/ FI-XB30SSRL-HF16
Mating Housing Part Number	FI-X30S-H (Unlocked Type) or equivalent

7.1.2 Pin Assignment

Pin#	Signal Name	Pin#	Signal Name
1	RxOIN0-	2	RxOIN0+
3	RxOIN1-	4	RxOIN1+
5	RxOIN2-	6	RxOIN2+
7	GND	8	RxOCLKIN-
9	RxOCLKIN+	10	RxOIN3-
11	RxOIN3+	12	RxEIN0-
13	RxEIN0+	14	GND
15	RxEIN1-	16	RxEIN1+
17	GND	18	RxEIN2-
19	RxEIN2+	20	RxECLKIN-
21	RxECLKIN+	22	RxEIN3-
23	RxEIN3+	24	GND
25	NC	26	NC
27	LVDS Format	28	VCC
29	VCC	30	VCC

7.2 Backlight Unit

Physical interface is described as for the connector on module. These connectors are capable of accommodating the following signals and will be following components.

Connector Name / Designation	Lamp Connector / Backlight lamp
Manufacturer	YEONHO or compatible
Type Part Number	35001HS-02L
Mating Type Part Number	35001WR-02L or SM02B-BHSS-1-TB

7.2.1 Signal for Lamp connector

	Connector No.	Pin No.	Input	Color	Function
Upper	CN1	1	Hot1	Sky Blue	High Voltage (Lamp 1)
		2	Cold1	Black	Low Voltage (Lamp 1)
	CN2	1	Hot2	Pink	High Voltage (Lamp 2)
		2	Cold2	White	Low Voltage (Lamp 2)

	Connector No.	Pin No.	Input	Color	Function
Lower	CN3	1	Hot1	Sky Blue	High Voltage (Lamp 3)
		2	Cold1	Black	Low Voltage (Lamp 3)
	CN4	1	Hot2	Pink	High Voltage (Lamp 4)
		2	Cold2	White	Low Voltage (Lamp 4)

8. Reliability Test

Environment test conditions are listed as following table.

Items	Required Condition	Note
Temperature Humidity Bias (THB)	Ta= 50°C, 80%RH, 300hours	
High Temperature Operation (HTO)	Ta= 50°C, 300hours	
Low Temperature Operation (LTO)	Ta= 0°C, 300hours	
High Temperature Storage (HTS)	Ta= 60°C, 300hours	
Low Temperature Storage (LTS)	Ta= -20°C, 300hours	
Vibration Test (Non-operation)	Acceleration: 1.5 G Wave: Random Frequency: 10 - 200 - 10 Hz Sweep: 30 Minutes each Axis (X, Y, Z)	
Shock Test (Non-operation)	Acceleration: 50 G Wave: Half-sine Active Time: 20 ms Direction: ±X, ±Y, ±Z (one time for each Axis)	
Drop Test	Height: 60 cm, package test	
Thermal Shock Test (TST)	-20°C/30min, 60°C/30min, 100 cycles	1
On/Off Test	On/10sec, Off/10sec, 30,000 cycles	
ESD (ElectroStatic Discharge)	Contact Discharge: ± 8KV, 150pF(330Ω) 1sec, 8 points, 25 times/ point.	2
	Air Discharge: ± 15KV, 150pF(330Ω) 1sec 8 points, 25 times/ point.	
Altitude Test	Operation:10,000 ft Non-Operation:30,000 ft	

Note 1: The TFT-LCD module will not sustain damage after being subjected to 100 cycles of rapid temperature change. A cycle of rapid temperature change consists of varying the temperature from -20°C to 60°C, and back again. Power is not applied during the test. After temperature cycling, the unit is placed in normal room ambient for at least 4 hours before power on.

Note 2: According to EN61000-4-2 , ESD class B: Some performance degradation allowed. No data lost. Self-recoverable. No hardware failures.

9. Shipping Label

The shipping label format is shown as below.



10. Mechanical Characteristics

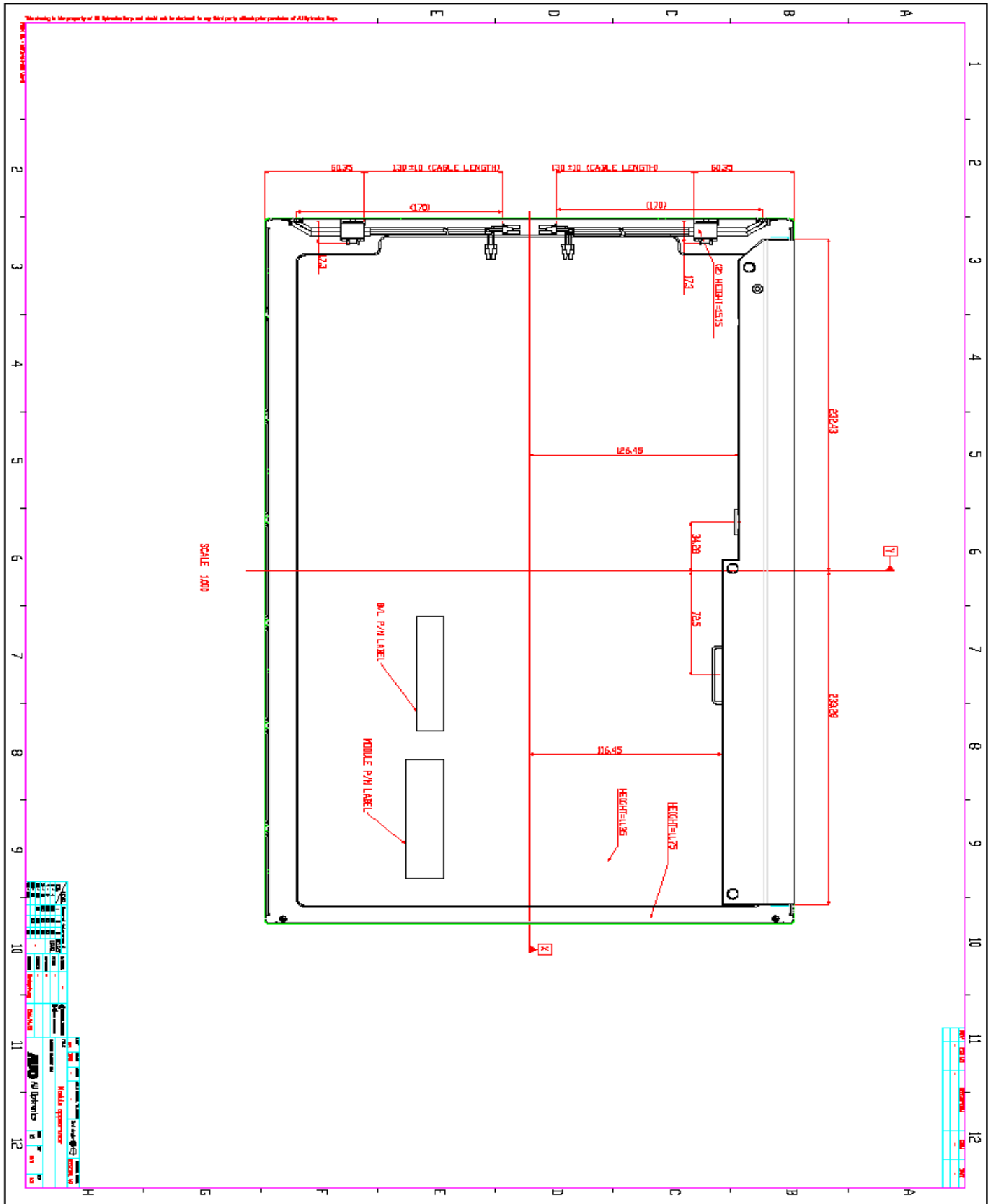



SECTION A-A
SCALE 2.000

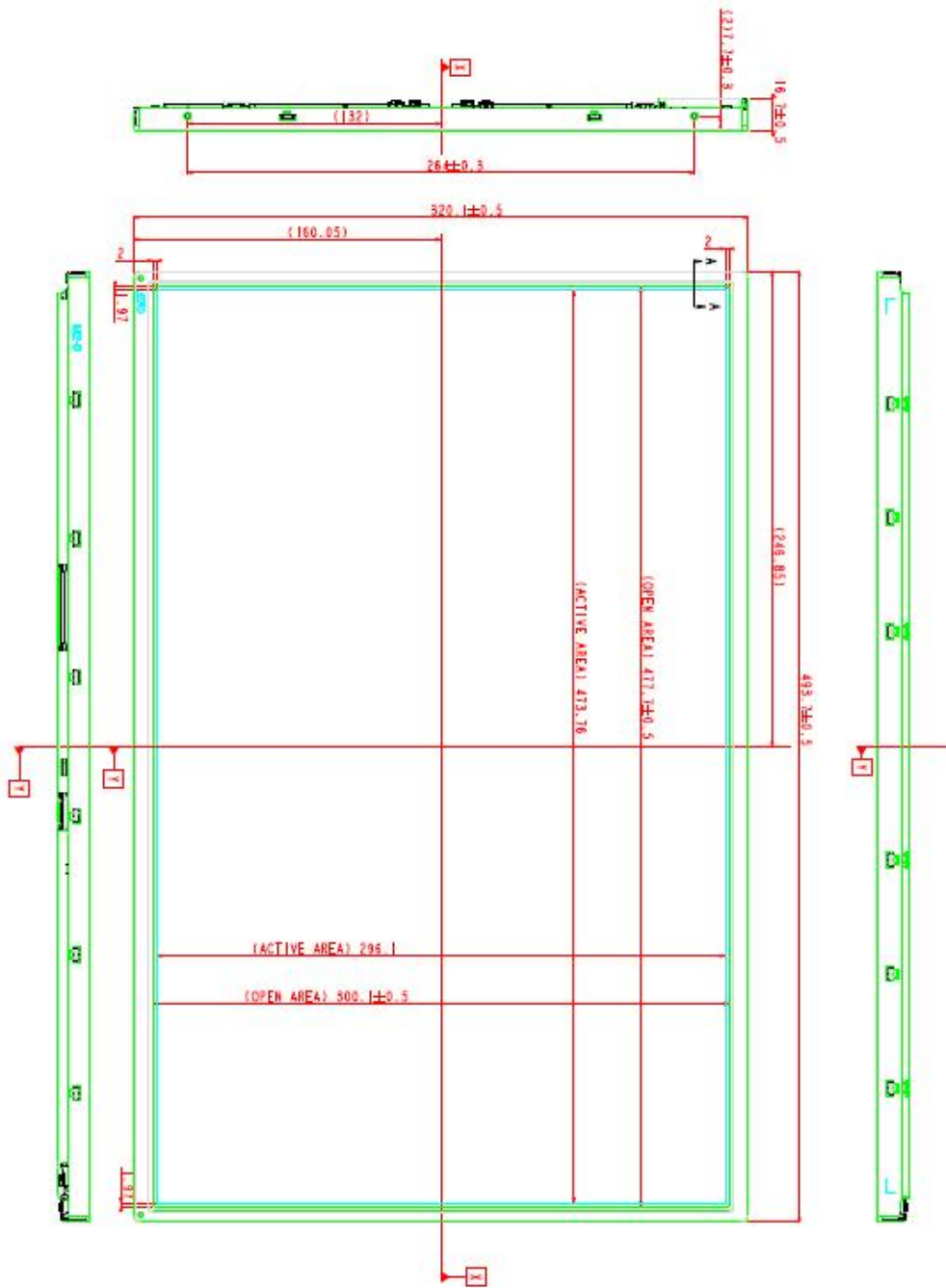

SCALE 0.800

- NOTES:
1. THE DIMENSION EXCLUDES DEFORMATION.
 2. THIS PANEL ATTACHED TO THE 400 SMM.
 3. LAMP CABLE CONNECTOR TO BE 350.00-001 OR COMPATIBLE.
 4. I/F CONNECTOR TO BE FI-1830SSI-HR15 (LAMP) OR COMPATIBLE.
 5. BACKLIGHT - 4 COLD CATHODE FLUORESCENT LAMPS.
 6. TORQUE OF NS USER HOLE SHOULD BE WITHIN 4.97-CM AND JUST RESCREW 10 TIMES.
 7. DISPLAY AREA POSITION TOLERANCE ARE AS FOLLOWING:
 (1) I-A-B ± 1.0mm
 (2) I-C-D ± 1.0mm

